

4b

Lexical analysis Finite Automata

Finite Automata (FA)

- FA also called Finite State Machine (FSM)
 - Abstract model of a computing entity.
 - Decides whether to accept or reject a string.
 - Every regular expression can be represented as a FA and vice versa
- Two types of FAs:
 - Non-deterministic (NFA): Has more than one alternative action for the same input symbol.
 - Deterministic (DFA): Has at most one action for a given input symbol.
- Example: how do we write a program to recognize the Java keyword “int”?

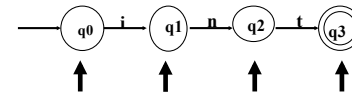

RE and Finite State Automaton (FA)

- Regular expressions are a declarative way to describe the tokens
 - Describes *what* is a token, but not *how* to recognize the token
- FAs are used to describe *how* the token is recognized
 - FAs are easy to simulate in a programs
- There is a 1-1 correspondence between FAs & regular expressions
 - A scanner generator (e.g., lex) bridges the gap between regular expressions and FAs.

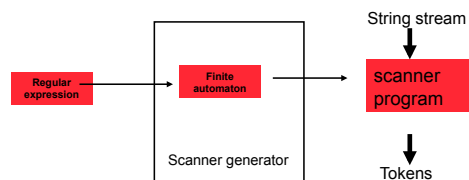

Inside scanner generator

Main components of scanner generation (e.g., Lex)

- Convert a regular expression to a non-deterministic finite automaton (NFA)
- Convert the NFA to a deterministic finite automaton (DFA)
- Improve the DFA to minimize the number of states
- Generate a program in C or some other language to “simulate” the DFA

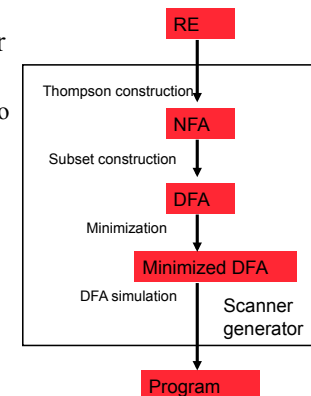

Non-deterministic Finite Automata (FA)

- NFA (Non-deterministic Finite Automaton) is a 5-tuple $(S, \Sigma, \delta, S_0, F)$:
 - S : a set of states;
 - Σ : the symbols of the input alphabet;
 - δ : a set of transition functions;
 - » $\text{move}(\text{state}, \text{symbol}) \rightarrow$ a set of states
 - S_0 : $s_0 \in S$, the start state;
 - F : $F \subseteq S$, a set of final or accepting states.
- Non-deterministic -- a state and symbol pair can be mapped to a set of states.
- Finite—the number of states is finite.

Transition Diagram

- FA can be represented using transition diagram.
- Corresponding to FA definition, a transition diagram has:
 - **States** represented by circles;
 - An **Alphabet** (Σ) represented by labels on edges;
 - **Transitions** represented by labeled directed edges between states. The label is the input symbol;
 - One **Start State** shown as having an arrow head;
 - One or more **Final State(s)** represented by double circles.
- Example transition diagram to recognize $(a|b)^*abb$

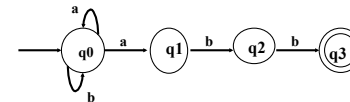

Simple examples of FA

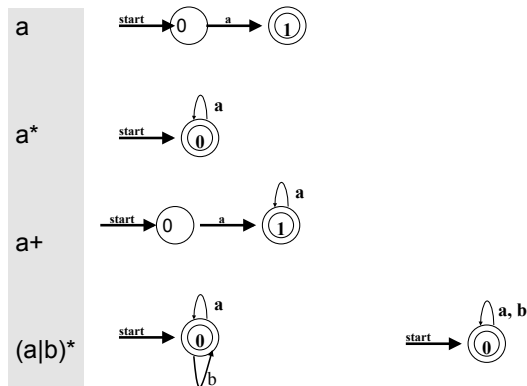

Procedures of defining a DFA/NFA

- Defining input alphabet and initial state
- Draw the transition diagram
- Check
 - Do all states have out-going arcs labeled with all the input symbols (DFA)
 - Any missing final states?
 - Any duplicate states?
 - Can all strings in the language can be accepted?
 - Are any strings not in the language accepted?
- Naming all the states
- Defining $(S, \Sigma, \delta, q_0, F)$

Example of constructing a FA

- Construct a DFA that accepts a language L over the alphabet {0, 1} such that L is the set of all strings with *any* number of “0”s followed by *any* number of “1”s.
- Regular expression: 0^*1^*
- $\Sigma = \{0, 1\}$
- Draw initial state of the transition diagram

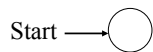

Example of constructing a FA

- Draft the transition diagram

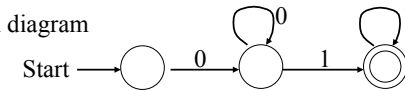

- Is “111” accepted?
- The leftmost state has missed an arc with input “1”

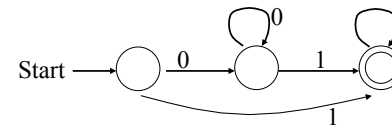

Example of constructing a FA

- Is “00” accepted?
- The leftmost two states are also final states
 - First state from the left: ϵ is also accepted
 - Second state from the left: strings with “0”s only are also accepted

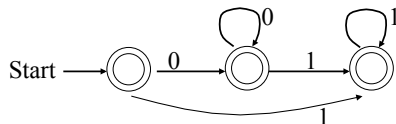

Example of constructing a FA

- The leftmost two states are duplicate
 - their arcs point to the same states with the same symbols

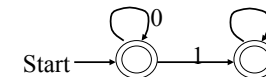

- Check that they are correct
 - All strings in the language can be accepted
 - » ϵ , the empty string, is accepted
 - » strings with “0”s / “1”s only are accepted
 - No strings not in language are accepted

- Naming all the states

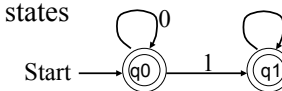

How does a FA work

- NFA definition for $(a|b)^*abb$

- $S = \{q_0, q_1, q_2, q_3\}$
- $\Sigma = \{a, b\}$
- Transitions: $move(q_0, a) = \{q_0, q_1\}$, $move(q_0, b) = \{q_0\}$, ...
- $s_0 = q_0$
- $F = \{q_3\}$

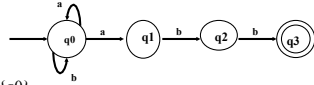

- Transition diagram representation

- Non-determinism:
 - » exiting from one state there are multiple edges labeled with same symbol, or
 - » There are epsilon edges.
- How does FA work? Input: ababb

$move(0, a) = 1$	$move(0, a) = 0$
$move(1, b) = 2$	$move(0, b) = 0$
$move(2, a) = ?$ (undefined)	$move(0, a) = 1$
	$move(1, b) = 2$
	$move(2, b) = 3$
REJECT!	ACCEPT!

FA for $(a|b)^*abb$

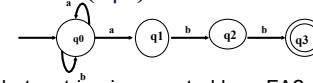

- What does it mean that a string is accepted by a FA?

An FA accepts an input string x iff there is a path from start to a final state, such that the edge labels along this path spell out x ;

- A path for "aabb": $Q_0 \rightarrow^a q_0 \rightarrow^a q_1 \rightarrow^b q_2 \rightarrow^b q_3$

- Is "aab" acceptable?

$Q_0 \rightarrow^a q_0 \rightarrow^a q_1 \rightarrow^b q_2$

$Q_0 \rightarrow^a q_0 \rightarrow^a q_0 \rightarrow^b q_0$

- » Final state must be reached;

- » In general, there could be several paths.

- Is "aabbb" acceptable?

$Q_0 \rightarrow^a q_0 \rightarrow^a q_1 \rightarrow^b q_2 \rightarrow^b q_3$

- » Labels on the path must spell out the entire string.

Transition table

- A transition table is a good way to implement a FSA
 - One row for each state, S
 - One column for each symbol, A
 - Entry in cell (S, A) gives set of states can be reached from state S on input A
- A Nondeterministic Finite Automaton (NFA) has at least one cell with more than one state
- A Deterministic Finite Automaton (DFA) has a single state in every cell

$(a|b)^*abb$

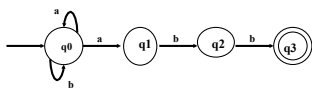

STATES	INPUT	
	a	b
>Q0	{q0, q1}	q0
Q1	q1	q2
Q2		q3
*Q3		

DFA (Deterministic Finite Automaton)

- A special case of NFA where the transition function maps the pair (state, symbol) to one state.
 - When represented by transition diagram, for each state S and symbol a , there is at most one edge labeled a leaving S ;
 - When represented transition table, each entry in the table is a single state.
 - There are no ϵ -transition
- Example: DFA for $(a|b)^*abb$

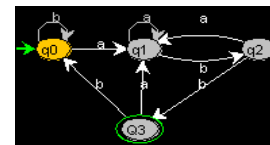

STATES	INPUT	
	a	b
q0	q1	q0
q1	q1	q2
q2	q1	q3
q3	q1	q0

- Recall the NFA:



DFA to program

- NFA is more concise, but not as easy to implement;
- In DFA, since transition tables don't have any alternative options, DFAs are easily simulated via an algorithm.
- Every NFA can be converted to an equivalent DFA
 - What does equivalent mean?
- There are general algorithms that can take a DFA and produce a “minimal” DFA.
 - Minimal in what sense?
- There are programs that take a regular expression and produce a program based on a minimal DFA to recognize strings defined by the RE.
- You can find out more in 451 (automata theory) and/or 431 (Compiler design)

